



DIŞ AÇMA

DIŞ AÇMA TAKIMLARI
THREADING TOOLHOLDERS



S

1

E

2

R

3

25 25

4-5

M

6

16

7

C

8

1 Sıkma Tipi
Method of Mounting of Insert

S: Vida Sıkmalı
S: Screw Clamping

2 İşlem Tipi
Application

E: Dış / External
I: İç / Internal

3 Kesme Yönü
Cutting Direction

R: Sağ Yan / Right - Hand
L: Sol Yan / Left - Hand

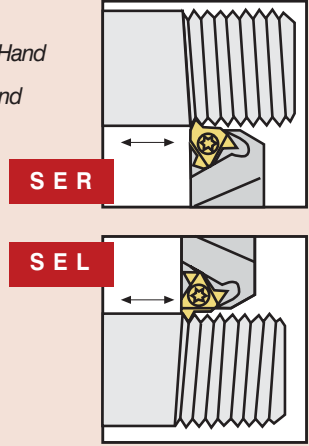

4 Takım Malzemesi / Type of Boring Bar

"A" Yekpare çelik gövde soğutma suyu kanallı / "A" Solid steel with coolant hole
"E" Çelik başlıkla sert metal gövde ve soğutma suyu kanallı /
"E" Carbide bar with fixed steel head and coolant hole
"C" KARBÜR ŞAFT / "C" Carbide shank
"S" Çelik Şaft / "S" Steel shank

4-5 Dış Çap Şaft Ölçüleri
External Shank Size

Şaft : hxb / Shank : hxb
2525 - 25 x 25 mm

5 Şaft Çapı / Shank Diameter

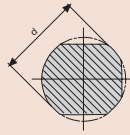

6 Şaft Boyu / Shank Length

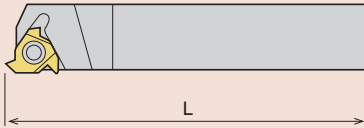

			(mm)
A - 32	H - 100	Q - 180	x-special
B - 40	J - 110	R - 200	
C - 50	K - 125	S - 250	
D - 60	L - 140	T - 300	
E - 70	M - 150	U - 350	
F - 80	N - 160	V - 400	
G - 90	P - 170	W - 450	

7 Elmas Ölçüsü
Insert Size

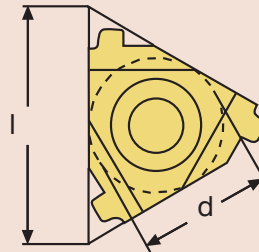

l (mm)	d
06	5/32"
08	3/16"
11	1/4"
16	3/8"
22	1/2"
27	5/8"

8 Baskı Pabucu
Wedge Clamp

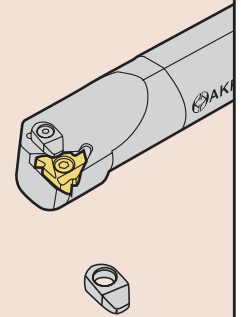

S

1

I

2

R

3

S

4

25

5

R

6

16

7

C

8

DIŞ ÇAP DIŞ AÇMA TAKIMLARI

EXTERNAL THREADING TOOLHOLDERS

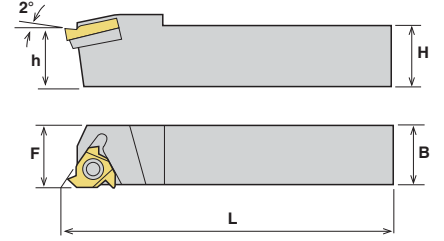
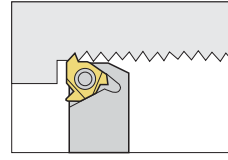

Takım Kod No Ordering Code	Stok Stock		Kater Ölçüleri (mm) Dimension (mm)				Kesici Uç Insert	Yedek Parçaları Spare Parts						
	R	L	h=H	B	L	F		Sıkma Vidası Clamp Screw	Altık Shim	Altık Vidası Shim Screw	Baskı Parçası Wedge Clamp	Baskı Vidası Screw	Tork Anahtar Torx Key	
SER/L 0808 E 11	○	○	08	08	70	11	11 ER/EL	1008-M2.5x7	-	-	-	-	-	80-T08
SER/L 1010 E 11	●	○	10	10	70	11								
SER/L 1616 H 16C	●	●	16	16	100	16	16 ER/EL	1015-M3.5x16	AATN-2-0020	AAV-06-M3.5x11	ACK-05	1515-M4x11	80-T15	
SER/L 2020 K 16C	●	●	20	20	125	20								
SER/L 2525 M 16C	●	●	25	25	150	25								
SER/L 3232 P 16C	●	●	32	32	170	32	22 ER/EL	1020-M4.5x16	AATN-2-0004	AAV-07-M4.5x11	ACK-05	1515-M4x11	80-T20	
SER/L 2525 M 22C	●	●	25	25	150	25								
SER/L 3232 P 22C	●	●	32	32	170	32	16 ER/L (1.5-3 TR)	1015-M3.5x9	-	-	ACK-05	1515-M4x11	80-T15	
SER/L 4040 S 22C	○	○	40	40	250	40								
SER/L 2525 M 16C-T	●	○	25	25	150	25	22 ER/L (4-6 TR)	1020-M4.5x16	-	-	ACK-05	1515-M4x11	80-T20	
SER/L 2525 M 22C-T	●	○	25	25	150	25								

R: Sağ/Right L: Sol/Left ● Stokta/In Stock ○ Stokta Yok/Non Stock Item

Sipariş Örneği/Ordering Example : 1 ad./pcs. SER 1010 E11

DELİK İÇİ DİŞ AÇMA TAKIMLARI

INTERNAL THREADING TOOLHOLDERS

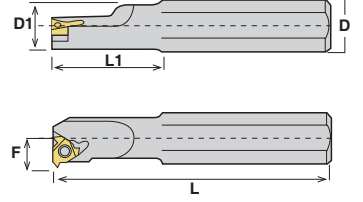
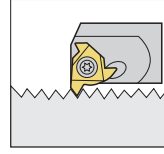

Takım Kod No Ordering Code	Stok Stock		Kater Ölçüleri (mm) Dimension (mm)					Kesici Uç Insert	Yedek Parçaları Spare Parts						
	R	L	D	D1	L	L1	F		D min	Sıkma Vidası Clamp Screw	Altık Shim	Altık Vidası Shim Screw	Baskı Parçası Wedge Clamp	Baskı Vidası Screw	Tork Anahtar Torx Key
SIR/L S16X07M 08	●	●	16	07	150	18	5.3	7.8	08 IR/L	1007-M2.2x4	-	-	-	-	80-T07
SIR/L S10H 11	○	○	10	10	100	-	7.4	12	11 IR/L	1008-M2.5x7	-	-	-	-	80-T08
SIR/L S12K 11	●	●	12	12	125	-	8.4	16							
SIR/L S16X10M 11	●	●	16	10	150	25	7.4	12							
SIR/L S16X13M 11	●	●	16	13	150	32	8.9	15							
SIR/L S16X13M 16	○	○	16	13	150	32	10.2	16	16 IR/L	1510-M3.5x9	-	-	-	-	80-T10
SIR/L S16M 16	●	●	16	16	150	-	11.7	19							
SIR/L S20X16P 16	○	○	20	16	170	40	11.7	19							
SIR/L S20P 16	●	●	20	20	170	-	13.7	24							
SIR/L S25R 16C	●	●	25	25	200	-	16.2	29							
SIR/L S32S 16C	●	●	32	32	250	-	19.7	36							
SIR/L S40T 16C	●	●	40	40	300	-	23.7	44	1015-M3.5x16	AATN-2-0020	AAV-06-M3.5x11	ACK-05	1515-M4x11	80-T15	
SIR/L S50U 16C	○	○	50	50	350	-	28.7	54							
SIR/L S20P 22	●	●	20	20	170	-	14	24							
SIR/L S25R 22C	●	●	25	25	200	-	18.1	29							
SIR/L S32S 22C	●	●	32	32	250	-	21.6	38	22 IR/L	1020-M4.5x16	AATN-2-0004	AAV-07-M4.5x11	ACK-05	1515-M4x11	80-T20
SIR/L S40T 22C	●	●	40	40	300	-	25.6	46							
SIR/L S50U 22C	○	○	50	50	350	-	30.6	58							
SIR/L S25R 16C-T	●	○	25	25	200	-	16.2	29	16 IR/L (1.5-3 TR)	1015-M3.5x9	-	-	-	-	80-T15
SIR/L S32S 16C-T	○	○	32	32	250	-	19.7	36	22 IR/L (4-6 TR)	1020-M4.5x16	-	-	-	-	80-T20
SIR/L S25R 22C-T	●	○	25	25	200	-	18.1	29							
SIR/L S32S 22C-T	●	○	32	32	250	-	21.6	38							

R: Sağ/Right L: Sol/Left ● Stokta/In Stock ○ Stokta Yok/Non Stock Item

Sipariş Örneği/Ordering Example : 1 ad./pcs. SIR S16x07M 08



KANAL AÇMA

KANAL AÇMA TAKIMLARI

GROOVING TOOLHOLDERS

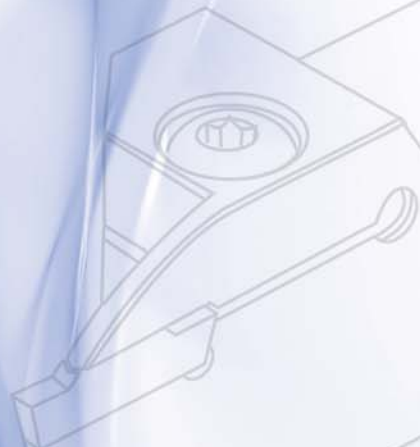

AKKO®
ADKT-ZCC2-R-25X25-3-T22
160508





AKKO **A** **AKT** - **K** - **R** - **2525**

Ø(100-150) - **4** - **T22**

2 Kesiş Stili / Cutter Style

DKT : Dış Çap Kanal Açma Takımı - External Grooving Toolholders
IKT : Delik İçi Kanal Açma Takımı - Internal Grooving Toolholders
AKT : Dış Çap Alın Kanal Açma Takımı - Face Grooving Toolholders

3 Uç Tipi / Insert Type

KRLY / MGM.
HRN / S312, S229, S224, S223
ISCR / GDM, GIM, GIP, GTN
SNDVK / 123, 151, 154.91
ZCC
KM / A4.
ARN / LOMR.

4 Kesme Yönü / Cutting Direction

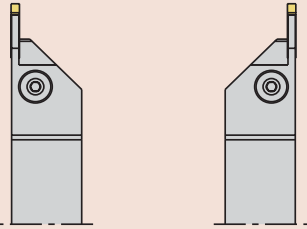

R

L

5 Kesme Kenar Yüksekliği ve Şaft Genişliği
Cutting Edge Height and Shank Width

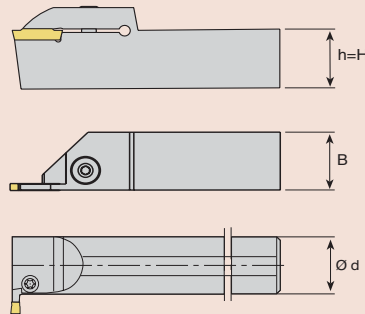

6 Kesme Aralığı / Cutting Diameter

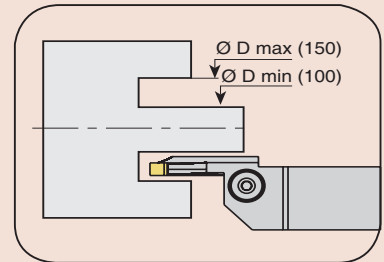

7 Kesme Kenar Genişliği / Cutting Width Edge

ÖR/E.G :
2 = 2.0 mm
3 = 3.0 mm
4 = 4.0 mm
5 = 5.0 mm
6 = 6.0 mm
8 = 8.0 mm



8 Kesme Derinliği / Cutting Depth

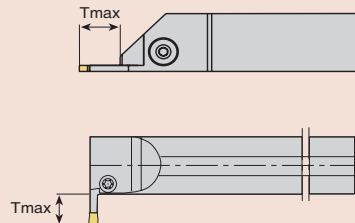

DIŞ ÇAP KANAL AÇMA TAKIMLARI

EXTERNAL GROOVING TOOLHOLDERS

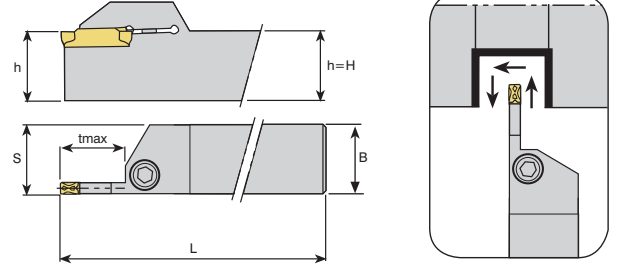

Takım Kod No Ordering Code	Stok Stock		Kater Ölçüleri (mm) Dimension (mm)					Kesici Uç Insert KRLY / MGM.	Yedek Parçaları Spare Parts						
	R	L	h=H	B	L	S	t max		Sıkma Vidası Clamp Screw	Pul Stamp	Anahtar Allen Key				
ADKT-K-R/L- 1212-2-T15	●	●	12	12	100	12.3	15	2	AKV-02-M6x20	ABPL-01	AAL-03-3				
ADKT-K-R/L- 1616-2-T15	●	●	16	16	100	16.3	15								
ADKT-K-R/L- 2020-2-T15	●	●	20	20	125	20.3	15								
ADKT-K-R/L- 2525-2-T15	●	●	25	25	150	25.3	15								
ADKT-K-R/L- 3232-2-T15	○	○	32	32	170	32.3	15								
ADKT-K-R/L- 1212-3-T15	●	○	12	12	100	12.3	15					3	2004-M8x1x20	-	AAL-05-4
ADKT-K-R/L- 1616-3-T15	●	●	16	16	100	16.4	15								
ADKT-K-R/L- 2020-3-T20	●	●	20	20	125	20.4	20								
ADKT-K-R/L- 2525-3-T22	●	●	25	25	150	25.4	22								
ADKT-K-R/L- 3232-3-T22	●	●	32	32	170	32.4	22								
ADKT-K-R/L- 2020-4-T20	●	●	20	20	125	20.4	20	4	2004-M8x1x20	-	AAL-05-4				
ADKT-K-R/L- 2525-4-T22	●	●	25	25	150	25.4	22								
ADKT-K-R/L- 3232-4-T22	●	●	32	32	170	32.4	22								
ADKT-K-R/L- 2020-5-T20	●	●	20	20	125	20.5	20					5	2004-M8x1x20	-	AAL-05-4
ADKT-K-R/L- 2525-5-T25	●	●	25	25	150	25.5	25								
ADKT-K-R/L- 3232-5-T25	●	●	32	32	170	32.5	25								
ADKT-K-R/L- 2525-6-T25	●	○	25	25	150	25.6	25	6	2004-M8x1x20	-	AAL-05-4				
ADKT-K-R/L- 3232-6-T25	●	●	32	32	170	32.6	25								
ADKT-K-R/L- 3232-8-T32	●	●	32	32	170	32.8	32								

R: Sağ/Right L: Sol/Left ● Stokta/In Stock ○ Stokta Yok/Non Stock Item

Sipariş Örneği/Ordering Example : 1 ad./pcs. ADKT-K-R-1212-2-T15

DIŞ ÇAP KANAL AÇMA TAKIMLARI

EXTERNAL GROOVING TOOLHOLDERS

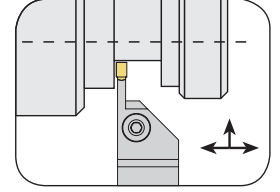
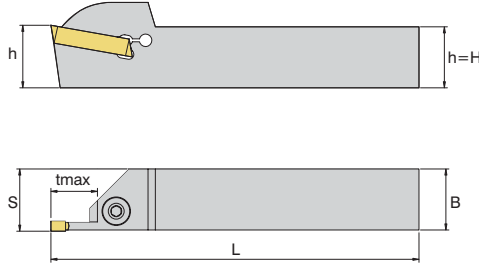

Takım Kod No Ordering Code	Stok Stock		Kater Ölçüleri (mm) Dimension (mm)				Kesici Uç Insert	Yedek Parçaları Spare Parts			
	R	L	h=H	B	L	S		t _{max}	Sıkma Vidası Clamp Screw	Pul Stamp	Anahtar Allen Key
								HRN / S229			
ADKT-H-R/L-2020-3-T20	●	●	20	20	125	20.5	20	3	2004-M8x1x20	-	AAL-05-4
ADKT-H-R/L-2525-3-T22	●	●	25	25	150	25.5	22				
ADKT-H-R/L-2020-4-T20	●	●	20	20	125	20.5	20				
ADKT-H-R/L-2525-4-T22	●	●	25	25	150	25.5	22				
ADKT-H-R/L-3232-4-T22	●	●	32	32	170	32.5	22				
ADKT-H-R/L-2020-5-T20	●	●	20	20	125	20.5	20				
ADKT-H-R/L-2525-5-T25	●	●	25	25	150	25.5	25				
ADKT-H-R/L-2525-6-T25	●	○	25	25	150	25.6	25				

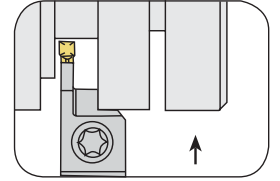
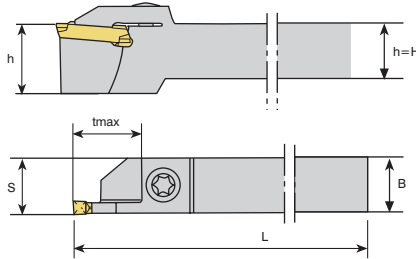

Takım Kod No Ordering Code	Stok Stock		Kater Ölçüleri (mm) Dimension (mm)				Kesici Uç Insert	Yedek Parçaları Spare Parts			
	R	L	h=H	B	L	S		t _{max}	Sıkma Vidası Clamp Screw	Pul Stamp	Anahtar Allen Key
								HRN / S224-S223			
ADKT-HK-R/L-1616 -2-T15	●	○	16	16	100	16.3	15	2	2004-M8x1x20	-	AAL-05-4
ADKT-HK-R/L-2020 -2-T15	●	●	20	20	125	20.3	15				
ADKT-HK-R/L-2525 -2-T15	●	●	25	25	150	25.3	15				
ADKT-HK-R/L-1616 -3-T15	○	○	16	16	100	16.3	15				
ADKT-HK-R/L-2020 -3-T20	●	●	20	20	125	20.4	20				
ADKT-HK-R/L-2525 -3-T22	●	●	25	25	150	25.4	22				
ADKT-HK-R/L-2020 -4-T20	●	●	20	20	125	20.4	20				
ADKT-HK-R/L-2525 -4-T22	●	●	25	25	150	25.4	22				
ADKT-HS223-R/L-2020-2-T15	●	○	20	20	125	20.4	15	2	AKV-02-M6x20	ABPL-01	AAL-03-3





R: Sağ/Right L: Sol/Left ● Stokta/In Stock ○ Stokta Yok/Non Stock Item

Sipariş Örneği/Ordering Example : 1 ad./pcs. ADKT-HK-R-1616-2-T15

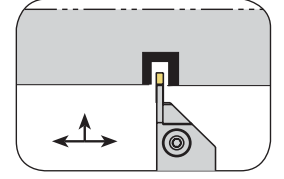
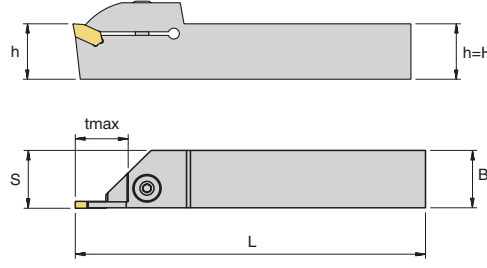





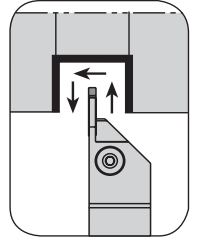
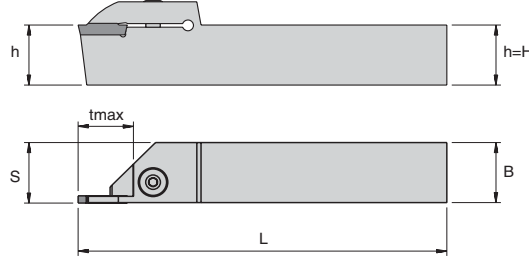

DIŞ ÇAP KANAL AÇMA TAKIMLARI

EXTERNAL GROOVING TOOLHOLDERS



Takım Kod No Ordering Code	Stok Stock		Kater Ölçüleri (mm) Dimension (mm)					Kesici Uç Insert	Yedek Parçaları Spare Parts		
	R	L	h=H	B	L	S	tmax		Sıkma Vidası Clamp Screw	Pul Stamp	Anahtar Allen Key
ADKT-ZCC1-R/L-2020-3-T20	●	○	20	20	125	20.3	20	ZCC1 			
ADKT-ZCC1-R/L-2525-3-T22	●	○	25	25	150	25.3	22				
ADKT-ZCC1-R/L-2020-4-T20	●	○	20	20	125	20.4	20	ZCC1 	2004-M8x1x20	-	AAL-05-4
ADKT-ZCC1-R/L-2525-4-T22	●	○	25	25	150	25.4	22				



Takım Kod No Ordering Code	Stok Stock		Kater Ölçüleri (mm) Dimension (mm)					Kesici Uç Insert	Yedek Parçaları Spare Parts		
	R	L	h=H	B	L	S	tmax		Sıkma Vidası Clamp Screw	Pul Stamp	Anahtar Allen Key
ADKT-ZCC2-R/L-2020-3-T20	●	●	20	20	125	20.3	20	ZCC2 			
ADKT-ZCC2-R/L-2525-3-T22	●	●	25	25	150	25.3	22				
ADKT-ZCC2-R/L-2020-4-T20	●	●	20	20	125	20.5	20	ZCC2 	2004-M8x1x20	-	AAL-05-4
ADKT-ZCC2-R/L-2525-4-T22	●	●	25	25	150	25.5	22				
ADKT-ZCC2-R/L-2020-5-T20	●	●	20	20	125	20.5	20	ZCC2 	2004-M8x1x20	-	AAL-05-4
ADKT-ZCC2-R/L-2525-5-T25	●	●	25	25	150	25.5	25				
ADKT-ZCC2-R/L-2020-6-T20	●	●	20	20	125	20.6	20	ZCC2 	2004-M8x1x20	-	AAL-05-4
ADKT-ZCC2-R/L-2525-6-T25	●	●	25	25	150	25.6	25				
ADKT-ZCC2-R/L-3232-6-T25	●	●	32	32	170	32.6	25	ZCC2 	2004-M8x1x20	-	AAL-05-4

R: Sağ/Right L: Sol/Left ● Stokta/In Stock ○ Stokta Yok/Non Stock Item

Sipariş Örneği/Ordering Example : 1 ad./pcs. ADKT-ZCC2-R-2020-3-T20

DIŞ ÇAP KANAL AÇMA TAKIMLARI EXTERNAL GROOVING TOOLHOLDERS

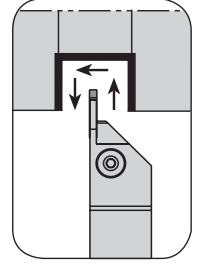
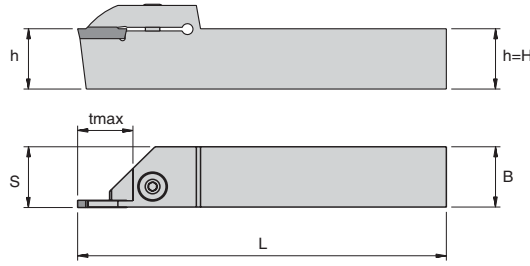

Takım Kod No Ordering Code	Stok Stock		Kater Ölçüleri (mm) Dimension (mm)					Kesici Uç Insert ISCR GIM-GIP-GTN-GDM	Yedek Parçaları Spare Parts		
	R	L	h=H	B	L	S	t _{max}		Sıkma Vidası Clamp Screw	Pul Stamp	Anahtar Allen Key
ADKT-I-R/L-1212-2-T15	○	○	12	12	100	12.3	15	2	AKV-02-M6x20	ABPL-01	AAL-03-3
ADKT-I-R/L-1616-2-T15	●	●	16	16	100	16.3	15				
ADKT-I-R/L-2020-2-T15	●	●	20	20	125	20.3	15				
ADKT-I-R/L-2525-2-T15	●	●	25	25	150	25.3	15	3	2004-M8x1x20	-	AAL-05-4
ADKT-I-R/L-1212-3-T15	●	○	12	12	100	12.3	15				
ADKT-I-R/L-1616-3-T15	●	●	16	16	100	16.4	15				
ADKT-I-R/L-2020-3-T20	●	●	20	20	125	20.4	20				
ADKT-I-R/L-2525-3-T22	●	●	25	25	150	25.4	22	4	AKV-02-M6x20	ABPL-01	AAL-03-3
ADKT-I-R/L-2020-4-T20	●	●	20	20	125	20.4	20				
ADKT-I-R/L-2525-4-T22	●	●	25	25	150	25.4	22	5	2004-M8x1x20	-	AAL-05-4
ADKT-IGIM-R/L-2020-2-T15	●	○	20	20	125	20.3	15				
ADKT-IGIM-R/L-2525-3-T22	●	○	25	25	150	25.4	22				
ADKT-IGIM-R/L-2525-5-T25	●	○	25	25	150	25.4	25	5	AKV-02-M6x20	ABPL-01	AAL-03-3
ADKT-IGIP-R/L-2020-2-T15	●	○	20	20	125	20.3	15				
ADKT-IGIP-R/L-1616-3-T15	●	○	16	16	100	16.4	15	3	2004-M8x1x20	-	AAL-05-4
ADKT-IGTN-R/L-2525-5-T25	●	○	25	25	150	25.6	25				

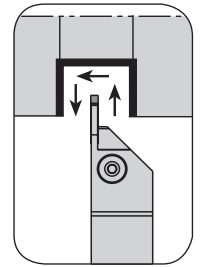
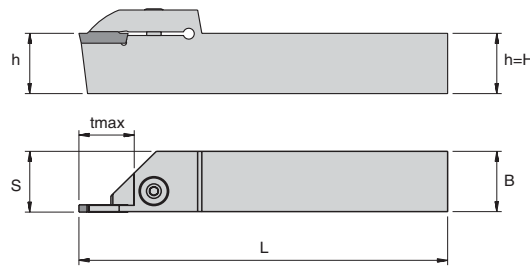

Takım Kod No Ordering Code	Stok Stock		Kater Ölçüleri (mm) Dimension (mm)					Kesici Uç Insert KM / A4.	Yedek Parçaları Spare Parts		
	R	L	h=H	B	L	S	t _{max}		Sıkma Vidası Clamp Screw	Pul Stamp	Anahtar Allen Key
ADKT-KM-R/L-2020-2-T15	●	●	20	20	125	20.3	15	2	AKV-02-M6x20	ABPL-01	AAL-03-3
ADKT-KM-R/L-2525-2-T15	●	○	25	25	150	25.3	15				
ADKT-KM-R/L-2020-3-T20	●	○	20	20	125	20.4	20	3	2004-M8x1x20	-	AAL-05-4
ADKT-KM-R/L-2525-3-T22	●	○	25	25	150	25.4	22				
ADKT-KM-R/L-2525-4-T22	●	○	25	25	150	25.5	22				





R: Sağ/Right L: Sol/Left ● Stokta/In Stock ○ Stokta Yok/Non Stock Item

Sipariş Örneği/Ordering Example : 1 ad./pcs. ADKT-KM-R-2020-2-T15

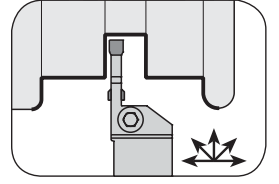
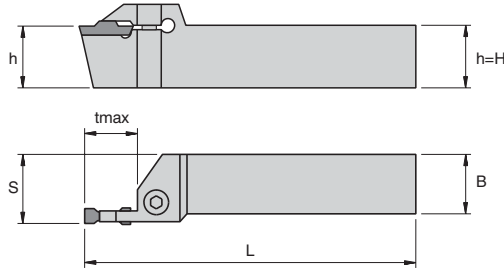







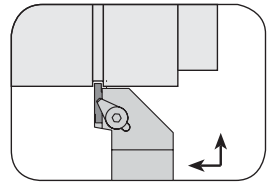
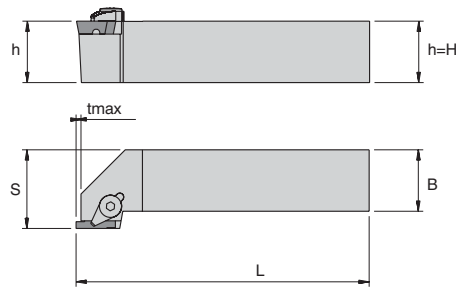



DIŞ ÇAP KANAL AÇMA TAKIMLARI

EXTERNAL GROOVING TOOLHOLDERS



Takım Kod No Ordering Code	Stok Stock		Kater Ölçüleri (mm) Dimension (mm)					Kesici Uç Insert	Yedek Parçaları Spare Parts			
	R	L	h=H	B	L	S	t _{max}		Sıkma Vidası Clamp Screw	Pul Stamp	Anahtar Allen Key	
ADKT-123-R/L-1616-2-T15	○	●	16	16	100	16.3	15	SNDVK / 123 				
ADKT-123-R/L-2020-2-T15	●	●	20	20	125	20.3	15					2
ADKT-123-R/L-2525-2-T15	●	●	25	25	150	25.3	15	SNDVK / 123 	2004-M8x1x20	-	AAL-05-4	
ADKT-123-R/L-1616-3-T15	○	●	16	16	100	16.4	15					3
ADKT-123-R/L-2020-3-T20	●	●	20	20	125	20.4	20					4
ADKT-123-R/L-2525-3-T22	●	●	25	25	150	25.4	22					5
ADKT-123-R/L-2020-4-T20	●	●	20	20	125	20.4	20					5
ADKT-123-R/L-2525-4-T22	●	●	25	25	150	25.4	22					
ADKT-123-R/L-2020-5-T20	●	●	20	20	125	20.5	20					
ADKT-123-R/L-2525-5-T25	●	●	25	25	150	25.5	25					



Takım Kod No Ordering Code	Stok Stock		Kater Ölçüleri (mm) Dimension (mm)					Kesici Uç Insert	Yedek Parçaları Spare Parts				
	R	L	h=H	B	L	S	t _{max}		Baskı Parçası Wedge Clamp	Sıkma Vidası Clamp Screw	Yay Spring	Pul Stamp	Anahtar Allen Key
ADKT-154.91-R/L-2020-3-T4	●	●	20	20	125	20.4	4	SNDVK / 154.91 					
ADKT-154.91-R/L-2525-3-T4	●	●	25	25	150	25.4	4						
ADKT-154.91-R/L-2020-5-T5	●	●	20	20	125	20.5	5	SNDVK / 154.91 					
ADKT-154.91-R/L-2525-5-T5	●	●	25	25	150	25.5	5						

R: Sağ/Right L: Sol/Left ● Stokta/In Stock ○ Stokta Yok/Non Stock Item

Sipariş Örneği/Ordering Example : 1 ad./pcs. ADKT-154.91-R-2020-3-T4

DIŞ ÇAP KANAL AÇMA TAKIMLARI

EXTERNAL GROOVING TOOLHOLDERS

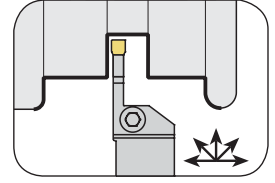
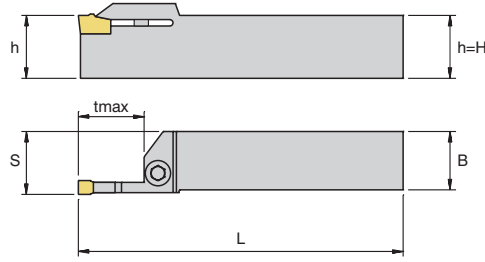

Takım Kod No Ordering Code	Stok Stock		Kater Ölçüleri (mm) Dimension (mm)				Kesici Uç Insert	Yedek Parçaları Spare Parts			
	R	L	h=H	B	L	S		t max	Sıkma Vidası Clamp Screw	Pul Stamp	Anahtar Allen Key
								SNDVK / 151.22			
ADKT-151.22-R/L-1616-2-T15	●	●	16	16	100	16.3	15	2	AKV-02-M6x20	ABPL-01	AAL-03-3
ADKT-151.22-R/L-2020-2-T15	●	●	20	20	125	20.3	15				
ADKT-151.22-R/L-2525-2-T15	●	●	25	25	150	25.3	15	3	2004-M8x1x20	-	AAL-05-4
ADKT-151.22-R/L-1616-3-T15	●	●	16	16	100	16.4	15				
ADKT-151.22-R/L-2020-3-T20	●	●	20	20	125	20.4	20	4			
ADKT-151.22-R/L-2525-3-T22	●	●	25	25	150	25.4	22				
ADKT-151.22-R/L-1616-4-T15	○	○	16	16	100	16.4	15	5			
ADKT-151.22-R/L-2020-4-T20	●	●	20	20	125	20.4	20				
ADKT-151.22-R/L-2525-4-T22	●	●	25	25	150	25.4	22				
ADKT-151.22-R/L-2020-5-T20	●	●	20	20	125	20.5	20				
ADKT-151.22-R/L-2525-5-T25	●	●	25	25	150	25.5	25				

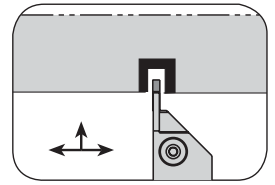
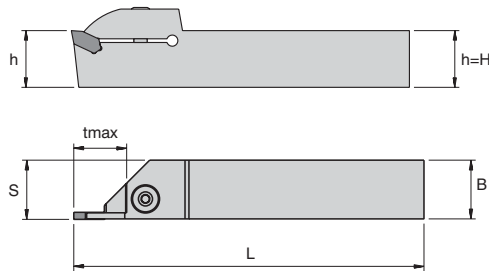

Takım Kod No Ordering Code	Stok Stock		Kater Ölçüleri (mm) Dimension (mm)				Kesici Uç Insert	Yedek Parçaları Spare Parts			
	R	L	h=H	B	L	S		t max	Sıkma Vidası Clamp Screw	Pul Stamp	Anahtar Allen Key
								ARN / LOMR.			
ADKT-ARN-R/L-2020-2-T15	●	●	20	20	125	20.3	15	2	AKV-02-M6x20	ABPL-01	AAL-03-3
ADKT-ARN-R/L-2525-2-T15	●	●	25	25	150	25.3	15				
ADKT-ARN-R/L-2020-3-T20	●	●	20	20	125	20.4	20	3	2004-M8x1x20	-	AAL-05-4
ADKT-ARN-R/L-2525-3-T22	●	●	25	25	150	25.4	22				





R: Sağ/Right L: Sol/Left ● Stokta/In Stock ○ Stokta Yok/Non Stock Item

Sipariş Örneği/Ordering Example : 1 ad./pcs. ADKT-ARN-R-2020-2-T15

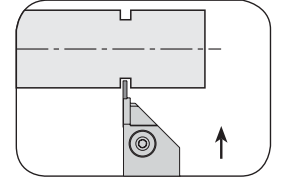
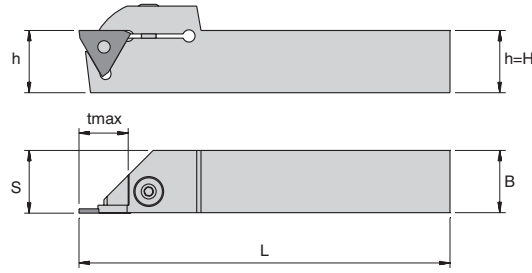
DIŞ ÇAP KANAL AÇMA TAKIMLARI

EXTERNAL GROOVING TOOLHOLDERS



Takım Kod No Ordering Code	Stok Stock		Kater Ölçüleri (mm) Dimension (mm)					Kesici Uç Insert	Yedek Parçaları Spare Parts		
	R	L	h=H	B	L	S	t max		Sıkma Vidası Clamp Screw	Pul Stamp	Anahtar Allen Key
ADKT-H22-R/L-1616-(0.5-2)-T6	●	●	16	16	100	16.2	6	HRN / S312 			
ADKT-H22-R/L-2020-(0.5-2)-T6	●	●	20	20	125	20.2	6	(05-2)	2004-M8x1x20	-	AAL-05-4
ADKT-H22-R/L-2525-(0.5-2)-T6	●	●	25	25	150	25.2	6				

R: Sağ/Right L: Sol/Left ● Stokta/In Stock ○ Stokta Yok/Non Stock Item





Sipariş Örneği/Ordering Example : 1 ad./pcs. ADKT-H22-R-1616-(0.5-2)-T6

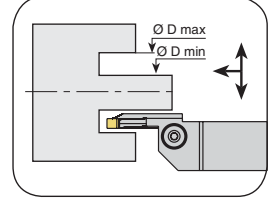
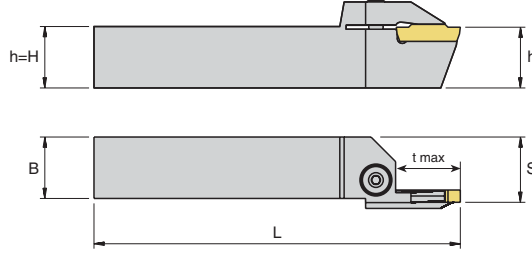

DIŞ ÇAP ALIN KANAL AÇMA TAKIMLARI

EXTERNAL GROOVING TOOLHOLDERS



Takım Kod No Ordering Code	Stok Stock		Kater Ölçüleri (mm) Dimension (mm)						Kesici Uç Insert	Yedek Parçaları Spare Parts			
	R	L	h=H	B	L	S	t max	Ø D min		Ø D max	Sıkma Vidası Clamp Screw	Pul Stamp	Anahtar Allen Key
AAKT-K-R/L-2525-Ø(34-45)-3-T17	●	●	25	25	150	26.5	17	34	45	KRLY / MGM. 			
AAKT-K-R/L-2525-Ø(39-55)-3-T17	●	●	25	25	150	26.5	17	39	55				
AAKT-K-R/L-2525-Ø(49-80)-3-T17	●	●	25	25	150	26.5	17	49	80				
AAKT-K-R/L-2525-Ø(70-110)-3-T17	●	○	25	25	150	26.5	17	70	110	3	2004-M8x1x20	-	AAL-05-4
AAKT-K-R/L-2525-Ø(100-150)-3-T17	●	○	25	25	150	26.5	17	100	150				
AAKT-K-R/L-2525-Ø(50-85)-4-T22	●	●	25	25	150	26.5	22	50	85				
AAKT-K-R/L-2525-Ø(70-110)-4-T22	●	●	25	25	150	26.5	22	70	110	4	2004-M8x1x20	-	AAL-05-4
AAKT-K-R/L-2525-Ø(100-150)-4-T22	●	○	25	25	150	26.5	22	100	150				
AAKT-K-R/L-2525-Ø(70-110)-5-T25	●	●	25	25	150	26.5	25	70	110	5	2004-M8x1x20	-	AAL-05-4
AAKT-K-R/L-2525-Ø(100-150)-5-T25	●	●	25	25	150	26.5	25	100	150				
AAKT-K-R/L-2525-Ø(140-200)-5-T25	●	●	25	25	150	26.5	25	140	200				

R: Sağ/Right L: Sol/Left ● Stokta/In Stock ○ Stokta Yok/Non Stock Item

Sipariş Örneği/Ordering Example : 1 ad./pcs. AAKT-K-R-2525-Ø(34-45)-3-T17

DIŞ ÇAP ALIN KANAL AÇMA TAKIMLARI

EXTERNAL GROOVING TOOLHOLDERS

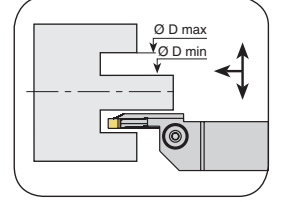
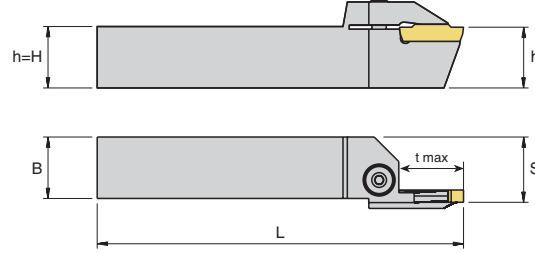

Takım Kod No
Ordering Code

Stok
Stock

Kater Ölçüleri (mm)
Dimension (mm)

Kesici Uç
Insert

Yedek Parçaları
Spare Parts

Sıkma Vidası
Clamp Screw

Pul
Stamp

Anahtar
Allen Key

R	L	h=H	B	L	S	t max	Ø D min	Ø D max
●	○	25	25	150	26.5	17	35	45
●	○	25	25	150	26.5	17	39	55
●	○	25	25	150	26.5	17	49	80
●	○	25	25	150	26.5	17	70	110
●	○	25	25	150	26.5	17	100	150
●	○	25	25	150	26.5	22	40	60
●	○	25	25	150	26.5	22	52	80
●	○	25	25	150	26.5	22	72	110
●	○	25	25	150	26.5	22	100	150
●	○	25	25	150	26.5	22	140	200
●	○	25	25	150	26.5	25	55	95
●	○	25	25	150	26.5	25	85	140
●	○	25	25	150	26.5	25	130	200
●	○	25	25	150	26.5	25	190	400

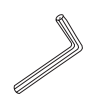
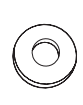

3

4

5

2004-M8x1x20

-

AAL-05-4



R: Sağ/Right L: Sol/Left ● Stokta/In Stock ○ Stokta Yok/Non Stock Item

Sipariş Örneği/Ordering Example : 1 ad./pcs. AAKT-ZCC2-R-2525-Ø(35-45)-3-T17



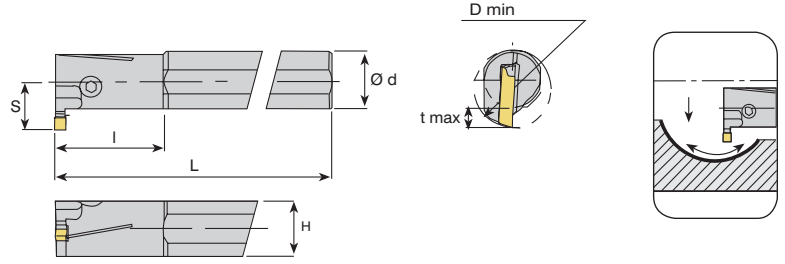

DELİK İÇİ KANAL AÇMA TAKIMLARI

INTERNAL GROOVING TOOLHOLDERS

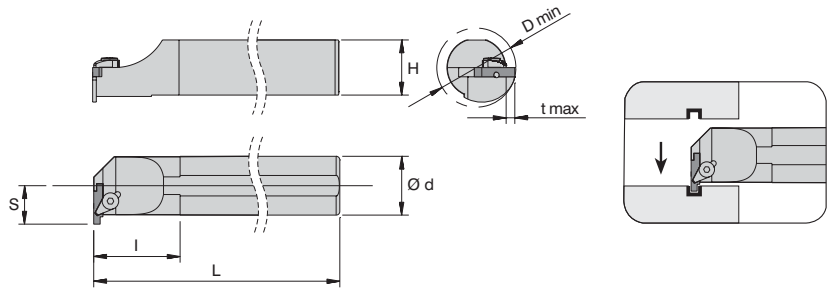

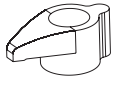
Takım Kod No Ordering Code	Stok Stock		Kater Ölçüleri (mm) Dimension (mm)						Kesici Uç Insert	Yedek Parçaları Spare Parts		
	R	L	d	D	L	I	t _{max}	H		S	Sıkma Vidası Clamp Screw	Anahtar Allen Key
										KRLY / MGM. 		
AIKT-K-R/L-16-2-T4	●	●	16	20	150	33	4	15	11.5	2	2503-M4x10	AAL-03-3
AIKT-K-R/L-20-2-T4	●	●	20	25	170	33	4	18	14.5		2503-M4x16	
AIKT-K-R/L-20-3-T6	●	●	20	25	170	33	6	18	15	3	2504-M5x16	AAL-05-4
AIKT-K-R/L-25-3-T6	●	●	25	31	200	45	6	23	18.5		2004-M8x1x20	
AIKT-K-R/L-32-3-T6	●	○	32	37	250	49	6	30	22	4	2504-M5x16	AAL-05-4
AIKT-K-R/L-40-3-T6	●	○	40	45	300	54	6	37	27		2004-M8x1x20	
AIKT-K-R/L-20-4-T6	●	○	20	25	170	34	6	18	14	4	2504-M5x16	AAL-05-4
AIKT-K-R/L-25-4-T6	●	●	25	31	200	43	6	23	18.5		2004-M8x1x20	
AIKT-K-R/L-32-4-T6	●	○	32	37	250	43	6	30	22	5	2504-M5x16	AAL-05-4
AIKT-K-R/L-40-4-T6	●	○	40	45	300	54	6	37	27		2004-M8x1x20	
AIKT-K-R/L-25-5-T7	●	●	25	31	200	43	7	23	18.5	5	2504-M5x16	AAL-05-4
AIKT-K-R/L-32-5-T7	●	○	32	37	250	50	7	30	22		2004-M8x1x20	
AIKT-K-R/L-40-5-T7	●	●	40	45	300	54	7	37	27			



Takım Kod No Ordering Code	Stok Stock		Kater Ölçüleri (mm) Dimension (mm)						Kesici Uç Insert	Yedek Parçaları Spare Parts				
	R	L	d	D	L	I	t _{max}	H		S	Baskı Parçası Wedge Clamp	Sıkma Vidası Clamp Screw	Yay Spring	Anahtar Allen Key
										SNDVK / 154.91 				
AIKT-154.91-R/L-16-3-T4	●	●	16	20	150	38	4	15	10.5	3	ACK-06	AKV-10-M6x15	-	AAL-05-4
AIKT-154.91-R/L-20-3-T4	●	●	20	25	170	40	4	18	13.5		ACK-03	AKV-07-M6x20	-	AAL-03-3
AIKT-154.91-R/L-25-3-T4	●	●	25	31	200	42	4	23	16.5	5				
AIKT-154.91-R/L-25-5-T5	●	●	25	31	200	42	5	23	16.5					
AIKT-154.91-R/L-32-5-T5	●	●	32	39	250	49	5	30	21.5					

R: Sağ/Right L: Sol/Left ● Stokta/In Stock ○ Stokta Yok/Non Stock Item

Sipariş Örneği/Ordering Example : 1 ad./pcs. AIKT-154.91-R-16-3-T4

DELİK İÇİ KANAL AÇMA TAKIMLARI

INTERNAL GROOVING TOOLHOLDERS

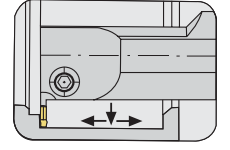
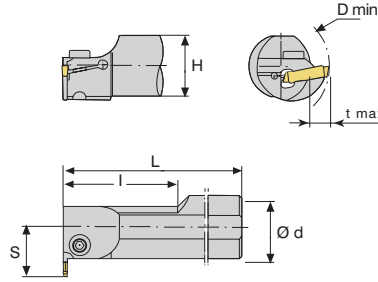

Takım Kod No Ordering Code	Stok Stock		Kater Ölçüleri (mm) Dimension (mm)						Kesici Uç Insert	Yedek Parçaları Spare Parts			
	R	L	d	D	L	I	t max	H		S	Sıkma Vidası Clamp Screw	Anahtar Allen Key	
										HRN / S229			
AIKT-H-R/L-25-3-T7	●	●	25	31	200	43	7	23	18.9	3		2504-M5x16	AAL-05-4
AIKT-H-R/L-32-3-T7	●	○	32	37	250	65	7	30	21.5			2004-M8x1x20	
AIKT-H-R/L-40-3-T7	●	○	40	45	300	50	7	37	26.5			2504-M5x16	
AIKT-H-R/L-25-4-T7	●	○	25	31	200	40	7	23	18.9	4	2504-M5x16		
AIKT-H-R/L-32-4-T7	●	●	32	37	250	65	7	30	21.5		2004-M8x1x20		
AIKT-H-R/L-40-4-T7	●	○	40	45	300	50	7	37	26.5	5	2504-M5x16		
AIKT-H-R/L-25-5-T7	●	○	25	31	200	45	7	23	18.9		2504-M5x16		
AIKT-H-R/L-32-5-T7	●	○	32	37	250	50	7	30	21.5		2004-M8x1x20		
AIKT-H-R/L-40-5-T7	●	○	40	45	300	70	7	37	26.5				

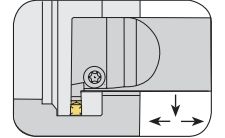
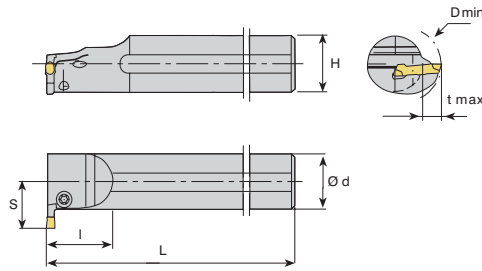

Takım Kod No Ordering Code	Stok Stock		Kater Ölçüleri (mm) Dimension (mm)						Kesici Uç Insert	Yedek Parçaları Spare Parts			
	R	L	d	D	L	I	t max	H		S	Sıkma Vidası Clamp Screw	Anahtar Allen Key	
										HRN / S223-S224			
AIKT-HK-R/L-20-2-T6	●	○	20	25	170	32	6	18	15	2		2503-M4x16	AAL-03-3
AIKT-HK-R/L-25-2-T6	●	○	25	31	200	42	6	23	18.9			2504-M5x16	
AIKT-HK-R/L-20-3-T6	●	○	20	25	170	33	6	18	15	3		2504-M5x16	AAL-05-4
AIKT-HK-R/L-25-3-T6	●	○	25	31	200	43	6	23	18.9			2004-M8x1x20	
AIKT-HK-R/L-32-3-T6	●	○	32	37	250	50	6	30	21.5			2504-M5x16	
AIKT-HK-R/L-20-4-T6	●	○	20	25	170	34	6	18	15	4		2504-M5x16	
AIKT-HK-R/L-25-4-T6	●	○	25	31	200	40	6	23	18.9			2004-M8x1x20	
AIKT-HK-R/L-32-4-T6	●	○	32	37	250	50	6	30	21.5	2		2504-M5x16	
AIKT-HS223-R/L-20-2-T5	●	○	20	25	170	32	5	18	15			2503-M4x16	AAL-03-3
AIKT-HS223-R/L-25-2-T5	●	○	25	31	200	42	5	23	18			2504-M5x16	AAL-05-4
AIKT-HS223-R/L-20-3-T6	●	○	20	25	170	32	6	18	15	3		2504-M5x16	
AIKT-HS223-R/L-20-3-T6	●	○	25	31	200	42	6	23	18				





R: Sağ/Right L: Sol/Left ● Stokta/In Stock ○ Stokta Yok/Non Stock Item

Sipariş Örneği/Ordering Example : 1 ad./pcs. AIKT-HK-R-20-2-T6

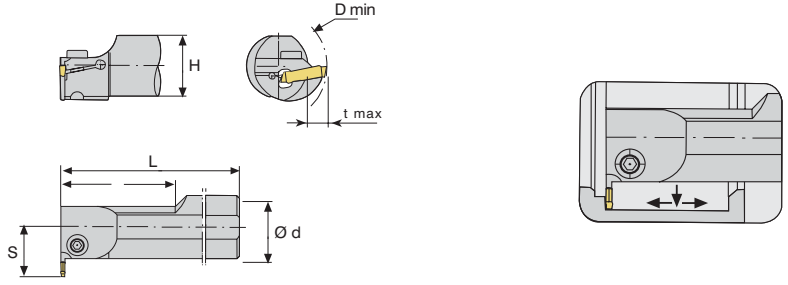



DELİK İÇİ KANAL AÇMA TAKIMLARI

INTERNAL GROOVING TOOLHOLDERS

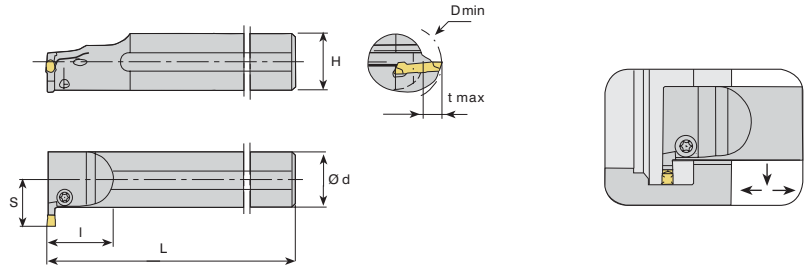

Takım Kod No Ordering Code	Stok Stock		Kater Ölçüleri (mm) Dimension (mm)						Kesici Uç Insert	Yedek Parçaları Spare Parts		
	R	L	d	D	L	I	t _{max}	H		S	Sıkma Vidası Clamp Screw	Anahtar Allen Key
AIKT-KM-R/L-20-2-T7	●	○	20	25	200	40	7	18	13	KM / A4. 		
AIKT-KM-R/L-20-3-T7	●	○	20	25	200	40	7	18	13			
AIKT-KM-R/L-25-3-T10	●	○	25	32	200	50	10	23	17	3 	2505-M6x20	AAL-07-5
AIKT-KM-R/L-32-3-T12	●	○	32	40	250	64	12	30	22			
AIKT-KM-R/L-40-3-T12	●	○	40	52	300	80	12	37	30	4 	2504-M5x16	AAL-05-4
AIKT-KM-R/L-20-4-T7	●	○	20	25	200	40	7	18	13			



Takım Kod No Ordering Code	Stok Stock		Kater Ölçüleri (mm) Dimension (mm)						Kesici Uç Insert	Yedek Parçaları Spare Parts		
	R	L	d	D	L	I	t _{max}	H		S	Sıkma Vidası Clamp Screw	Anahtar Allen Key
AIKT-ZCC2-R/L-20-3-T5	●	○	20	25	170	32	5	18	15	ZCC2 		
AIKT-ZCC2-R/L-25-3-T5	●	○	25	31	200	42	5	23	18			
AIKT-ZCC2-R/L-32-3-T6	●	○	32	45	250	42	6	30	22	4 	2004-M8x1x20	AAL-05-4
AIKT-ZCC2-R/L-25-4-T6	●	○	25	31	200	42	6	23	18			
AIKT-ZCC2-R/L-32-4-T7	●	○	32	37	250	42	7	30	22	5 	2004-M8x1x20	
AIKT-ZCC2-R/L-32-5-T8	●	○	32	37	250	42	8	30	22			
AIKT-ZCC2-R/L-40-5-T8	●	○	40	45	300	53	8	37	27			

R: Sağ/Right L: Sol/Left ● Stokta/In Stock ○ Stokta Yok/Non Stock Item

Sipariş Örneği/Ordering Example : 1 ad./pcs. AIKT-ZCC2-R-20-3-T5